

# Fiber Optic PIN Photodiode Type OPF470

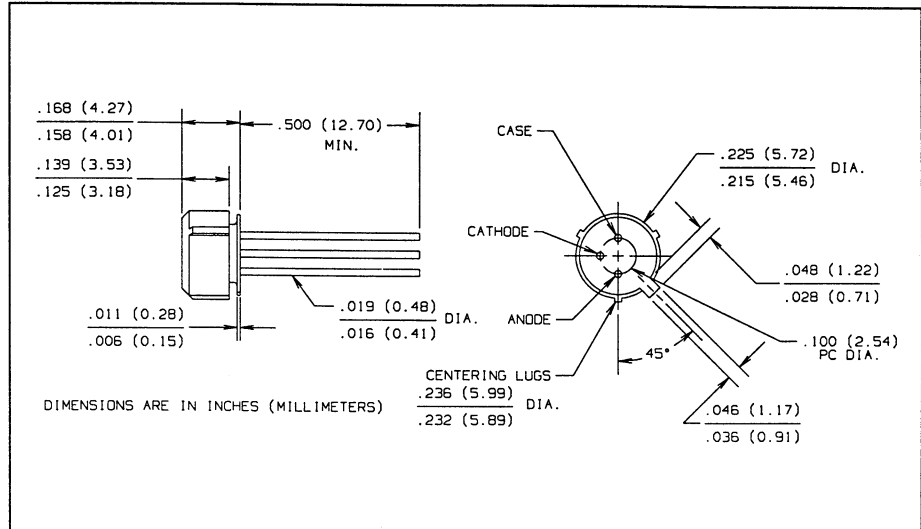
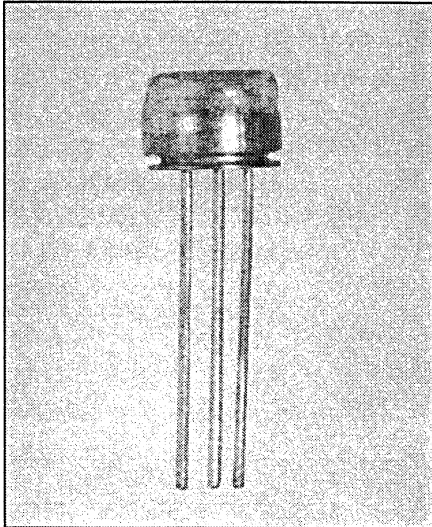

## Features

- Electrically isolated plastic cap package
- High speed, low capacitance
- Designed to self align in the 0.228 diameter bore of standard fiber optic receptacles
- Press fit simplifies component installation
- Optimized for fiber optic applications using 50 to 200 micron fiber

## Description

The OPF470 is a low noise silicon PIN photodiode mounted in a low cost package for fiber optic applications. It offers fast response at moderate bias and is compatible with LED and laser diode sources in the 800-900 nm wavelength region. Low capacitance improves signal to noise performance in typical short haul LAN applications.

The PIN Photodiodes are designed to interface with multimode optical fibers from 50/125 to 200/300 microns.

## Absolute Maximum Ratings ( $T_A = 25^\circ\text{C}$ unless otherwise noted)

Reverse Voltage	100 VDC
Continuous Power Dissipation	200 mW <sup>(1)</sup>
Storage Temperature Range	-55° C to +115° C
Operating Temperature Range	-40° C to +100° C
Lead Soldering Temperature [1/16 inch (1.6 mm) from case for 5 sec. with soldering iron].	240° C <sup>(2)</sup>

### Notes:

- (1) Derate linearly @ 2.0 mW/°C above 25° C.
- (2) RMA flux is recommended. Duration can be extended to 10 sec. max when flow soldering.
- (3) Test @  $V_R = 5\text{ V}$  with 50/125 micron, 0.20 N.A. fiber, @ 10  $\mu\text{W}$  optical power @ 850 nm. Responsivity levels apply to 50  $\mu\text{m}$ , 62.5  $\mu\text{m}$  and 100  $\mu\text{m}$  core optical fibers.
- (4)  $R_L = 50\ \Omega$ , 10%-90%

## Typical Performance Curves

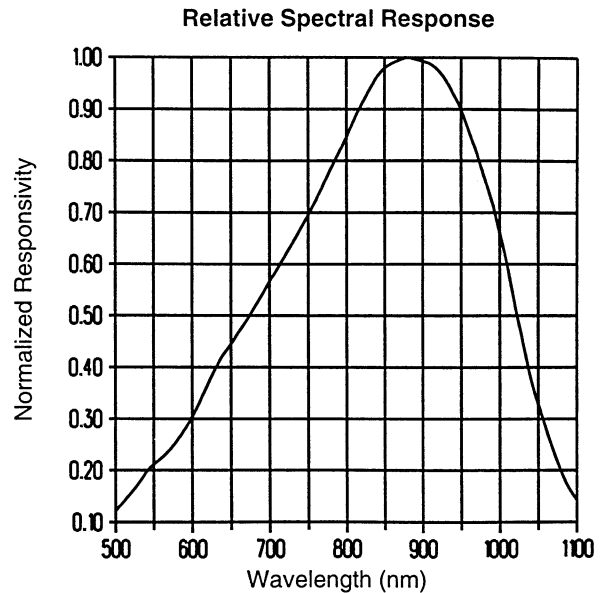

# Type OPF470

Electrical Characteristics ( $T_A = 25^\circ\text{C}$  unless otherwise noted)

SYMBOL	PARAMETER	MIN	TYP	MAX	UNITS	TEST CONDITIONS
R	Flux Responsivity	0.45	0.55		A/W	$V_R = 5.0\text{ V}^{(3)}$
$I_D$	Dark Current		0.1	5.0	nA	$V_R = 5.0\text{ V}$
$\lambda_p$	Peak Response Wavelength		880		nm	
$t_r$	Output Rise Time		6.0		ns	$V_R = 15\text{ V}^{(4)}$
$C_T$	Total Capacitance		3.0		pF	$V_R = 20\text{ V}$
FoV	Field of View		80		Deg.	

## TYPICAL PERFORMANCE CURVES

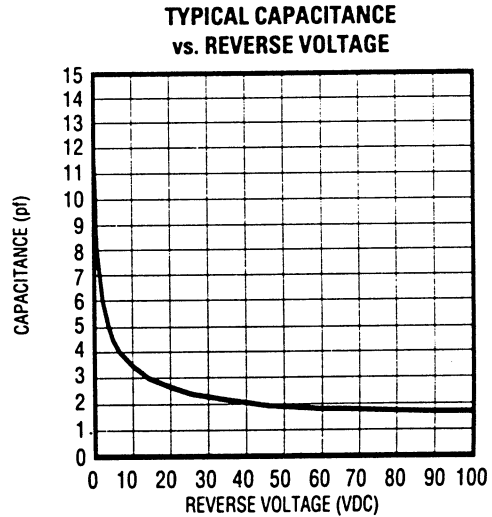
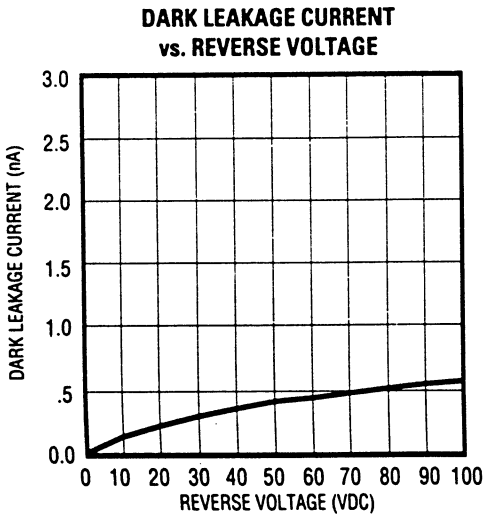
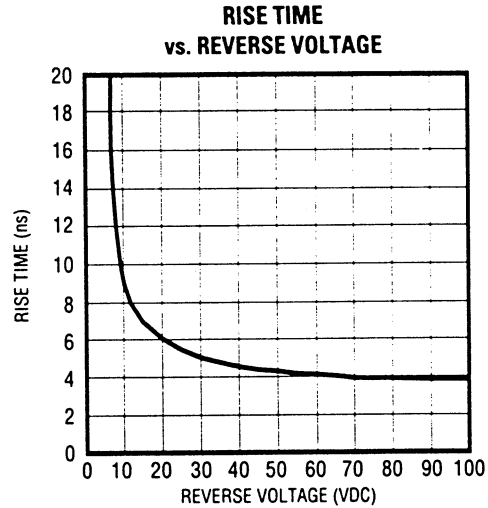
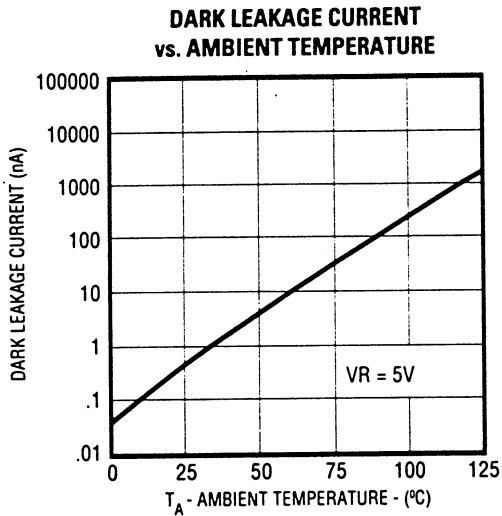

FIBER OPTIC COMPONENTS